

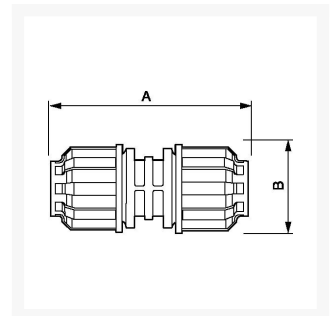

Acoplamiento de poliamida 50 mm

Product Images



Additional Information

SKU	9ALRUN50
EAN 13	3660058062206
Peso (kg)	0.517000
Presión máxima (bar)	13 at 40°C

