

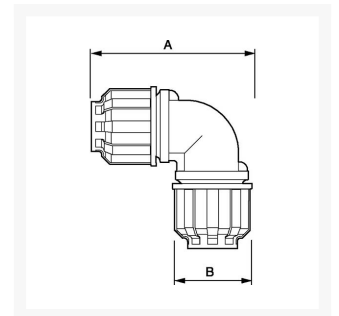

Acoplamiento de codo de poliamida 40 mm 90 grados

Product Images



Additional Information

SKU	9ALR9C40
EAN 13	08712418282603
Peso (kg)	0.396000
Longitud (mm)	129
Anchura (mm)	80
Construcción (material)	Polyamide
Diámetro Ø (mm)	40
Presión máxima (bar)	13 at 40°C

