

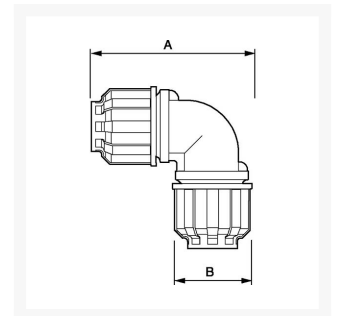

Acoplamiento de codo de poliamida 50 mm 90 grados

Product Images



Additional Information

SKU	9ALR9C50
EAN 13	08712418321906
Peso (kg)	0.583000
Longitud (mm)	150
Anchura (mm)	93
Construcción (material)	Polyamide
Diámetro Ø (mm)	50
Presión máxima (bar)	13 at 40°C

