

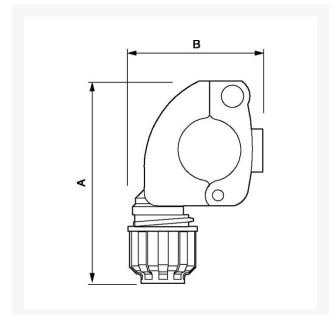

Tapón reductor de derivación rápida 50 x 20 mm

Product Images



Additional Information

SKU	9ALRBP5020
EAN 13	3660058060677
Peso (kg)	0.400000
Longitud (mm)	111
Altura (mm)	145
Construcción (material)	Polyamide
Diámetro Ø (mm)	50 x 20
Presión máxima (bar)	13 at 40°C

