

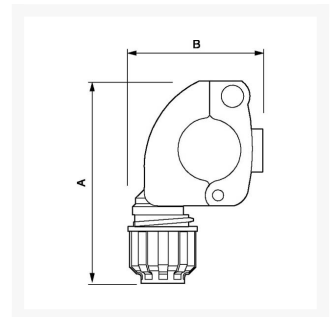

Tapón reductor de derivación rápida 63 x 25 mm

Product Images



Additional Information

SKU	9ALRBP6325
EAN 13	3660058060707
Peso (kg)	0.387000
Longitud (mm)	118
Altura (mm)	147
Construcción (material)	Polyamide
Diámetro Ø (mm)	63 x 25
Presión máxima (bar)	13 at 40°C

