

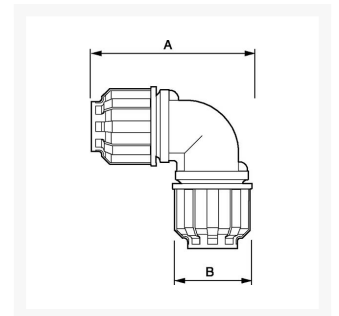

Acoplamiento de codo de poliamida 25 mm 90 grados

Product Images



Additional Information

SKU	9ALR9C25
EAN 13	08712418282580
Peso (kg)	0.141000
Longitud (mm)	109
Anchura (mm)	65
Construcción (material)	Polyamide
Diámetro Ø (mm)	25
Presión máxima (bar)	13 at 40°C

